



Santa·FeTM Rx



Installation & Operation Instructions

A unique dehumidifier solution that can be integrated into the living space. The **Santa Fe Rx** is a great solution for a living room, bedroom, office space, or anywhere that needs supplemental dehumidification. Its clean design blends into any home or office décor.

P/N: 4030440 Serial No.: _____ Install Date: _____

Sold by: _____

www.Santa-Fe-Products.com ■ 1.800.533.7533

Table of Contents

Safety Instructions	3
Intended Applications	3
Registrations.....	3
Specifications	4
Dehumidifier Set Up	5
Items Included In Box.....	5
Important Precautions	5
Location Considerations.....	5
Drain Installation	6
Operation	7
Humidity Control Adjustment.....	7
Fan Operation	7
Defrost Cycle.....	7
Air Filtration	8
Changing The Filter	8
MERV Rating Chart	9
Electrical Requirements	10
Service	11
Replacement Parts	11
Refrigerant Charging	11
Compressor / Capacitor Replacement	11
Troubleshooting	11
Warranty	13



4201 Lien Rd. Madison, WI 53704

1-800-533-7533

www.Thermastor.com | www.Santa-Fe-Products.com

© 2016 Therma-Stor LLC

Safety Instructions

READ THE INSTALLATION, OPERATION AND MAINTENANCE INSTRUCTIONS CAREFULLY BEFORE INSTALLING AND OPERATING THIS DEVICE. PROPER ADHERENCE TO THESE INSTRUCTIONS IS ESSENTIAL TO OBTAIN MAXIMUM BENEFIT FROM YOUR SANTA FE DEHUMIDIFIER.

WARNING!

THIS SYMBOL MEANS IMPORTANT INSTRUCTIONS. FAILURE TO HEED THEM CAN RESULT IN SERIOUS INJURY OR DEATH.

CAUTION!

THIS SYMBOL MEANS IMPORTANT INSTRUCTIONS. FAILURE TO HEED THEM CAN RESULT IN INJURY OR MATERIAL PROPERTY DAMAGE.

- Never operate a unit with a damaged power cord. If the power cord is damaged, it must be replaced by the manufacturer, its service agent, or a similarly qualified person in order to avoid a hazard.
- Do not unplug the unit by pulling on the cord. Grasp the plug firmly and pull it out of the wall socket or power receptacle.
- When plugging in the unit, use a Ground Fault Interrupter outlet.
- This appliance is not intended for use by persons (including children) with reduced physical, sensory or mental capabilities, or lack of experience or knowledge, unless they have been given supervision or instruction concerning the use of the appliance by a person responsible for their safety. Children should be supervised to ensure that they do not play with the appliance.
- Never operate electrical equipment near or in standing water.
- Do not stick your fingers or other objects in the unit.
- The unit must be used in the upright position.
- Do not restrict airflow in to or out of the unit. This may cause the unit to overheat.
- The unit should never be serviced or cleaned while it is plugged in.
- Do not sit or stand on the unit, or use as a shelf or table.
- Before leaving the unit unattended, ensure children do not have access to the equipment. Do not allow children to play with or near the unit or in its air flow.
- The unit is designed to be installed indoors only.
- No user serviceable components. Contact installer or call 1-800-533-7533 for all repair or warranty needs.

Intended Application(s)

The Santa Fe Rx can be used in living rooms, bedrooms, offices, etc. The unit can be placed in almost any residential setting where dehumidification is desired. Use in non-residential applications and pool areas may void warranty.

The Santa Fe Rx is designed to operate in temperatures between 60° and 95°F.

In order to efficiently control humidity levels, the area in which the dehumidifier is to be operated must be free of water intrusion or excessive fresh (outside) air infiltration. Before installing the Santa Fe Rx, water intrusion and air infiltration problems should be addressed.

Registrations



The Santa Fe Rx conforms to unified standard UL 60335-2-40 and CSA standard C22.2.60335-2-40.

Specifications

Part Number:	4030440
Blower:	230 CFM @ 0.0" WG
Power:	630 watts @ 80°F and 60% RH
Supply Voltage:	115 volt – 1phase – 60 Hz
Current Draw:	5.4 amps
Operating Temp.:	60°F Min., 95°F Max.
Sized For:	2,200 Sq. Ft. - Typical

Minimum Performance at:

	80°F and 60%RH	70°F and 60%RH
Water Removal:	74 Pints/Day	66 Pints/Day
Efficiency:	5.2 Pints/kWh	5.03 Pints/kWh
Energy Factor:	2.47 L/kWh	2.38 L/kWh

Air Filter:	MERV-13, Standard Pleat
Size:	16" x 20" x 2"
Power Cord:	10', 115 VAC, Ground
Drain Hose:	3/16" ID x 20', 15' Lift Capacity (Internal pump included)
Refrigerant Type:	R410A (Refer to manufacturers label for more information)
Refrigerant Amount:	1 lb., 8 oz.

Dimensions:	Unit	With Secondary Filter Housing	Shipping
Width:	23"	23"	24"
Height:	37.5"	37.5"	46"
Length:	20"	24.75"	26"
Weight:	130 lbs		146 lbs

Optional Accessories:

- 4021475 MERV-11 Filter (16" x 20" x 2")
- 4027420 MERV-11 Filters 4-Pack
- 4027424 MERV-11 Filters 12-Pack
- 4037723 MERV-13 Filter (16" x 20" x 2")
- 4037733 MERV-13 Filters 4-Pack
- 4037734 MERV-13 Filters 12-Pack
- 4023869 Filter Housing
- 4024145 HEPA Filter (needs filter housing)
- 4022489 MERV-14 Filter (16" x 20" x 2") fits 4023869, use 2)
- 4024528 Bulk Carbon Granules (5 gallon bucket)

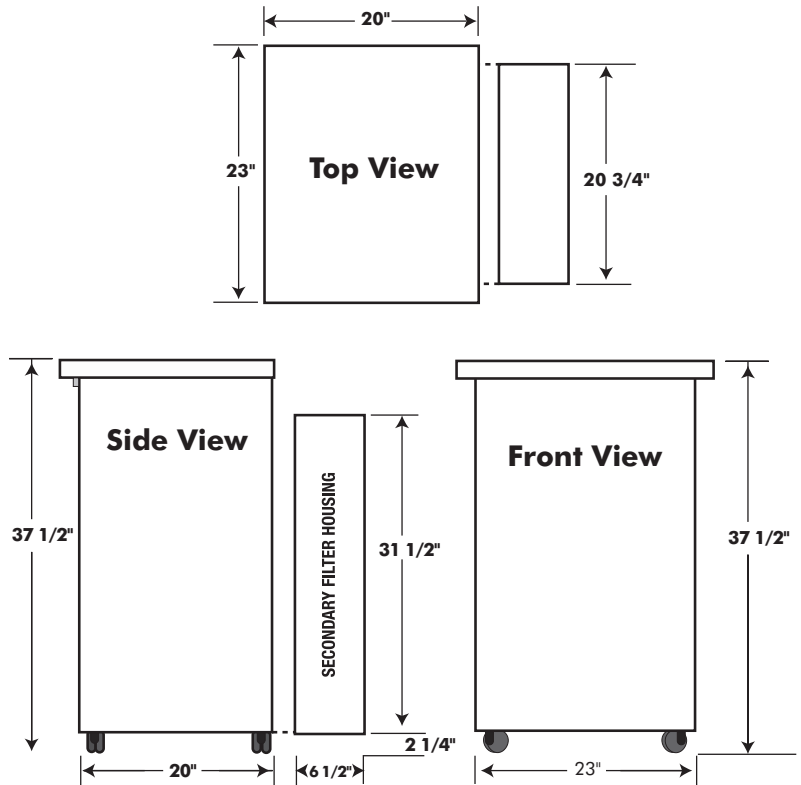

Dehumidifier Set Up

Items Included in Box:

- Santa Fe Rx Dehumidifier
- Santa Fe Rx Installation & Operation Instructions

Important Precautions

- The Santa Fe Rx is most effective if it is centrally located in the space to be dehumidified.
- It is designed to be placed with its back 3' (ft.) or more from a wall (the air outlet is located at the lower portion of the back). This will reduce noise and the likelihood that discharge air will blow directly at someone. Avoid directing the discharge air at people. The dehumidifier should be used in the upright position.
- Do not place the unit where curtains or debris can be drawn into the intake and restrict airflow.
- The device is designed to be installed indoors, ideally in a living space or basement, that is protected from rain and flooding.
- Do not operate in standing water or place the unit near open water. If used near a water source; be certain there is no chance the unit could fall into the water or get splashed and that it is plugged into a dedicated circuit and Ground Fault Circuit Interrupter (GFCI) protected outlet.
- The water removed by the Santa Fe Rx will be pumped through the 20' long hose coming from under its base. The hose (about the diameter of a TV coaxial cable) must be routed to a drain or outside. It can pump condensate 15' above the unit and can be extended.
- Install the unit with enough space to access the rear panel, the discharge air flow side of the unit for maintenance and service.
- The top can serve as a light duty table (maximum load: 20 lbs.), but it must be removed periodically to check the air filter.
- DO NOT use the dehumidifier as a bench or table.
- DO NOT place the dehumidifier directly on structural building members without vibration absorbers or unwanted noise may result.

Location Considerations

- Locate the dehumidifier near a suitable drain (drain hose included). Allow for proper drainage and routing of needed drain pipes.
- Locate the dehumidifier in an area where the cord's length (10') easily reaches a 115 VAC electrical outlet with a minimum of a 15 Amp circuit capacity.
- The unit is designed to operate while level. Failure to level the unit may result in leakage or improper drainage.
- A flooded unit is not covered by warranty.
- Allow sufficient clearance to handle the unit's overall dimensions as well as any optional return and supply ductwork to the unit.
- Allow sufficient clearance for filter removal and to prevent airflow obstruction.
- Electrical service access will require the removal of the front panel. Allow sufficient clearance around the unit.

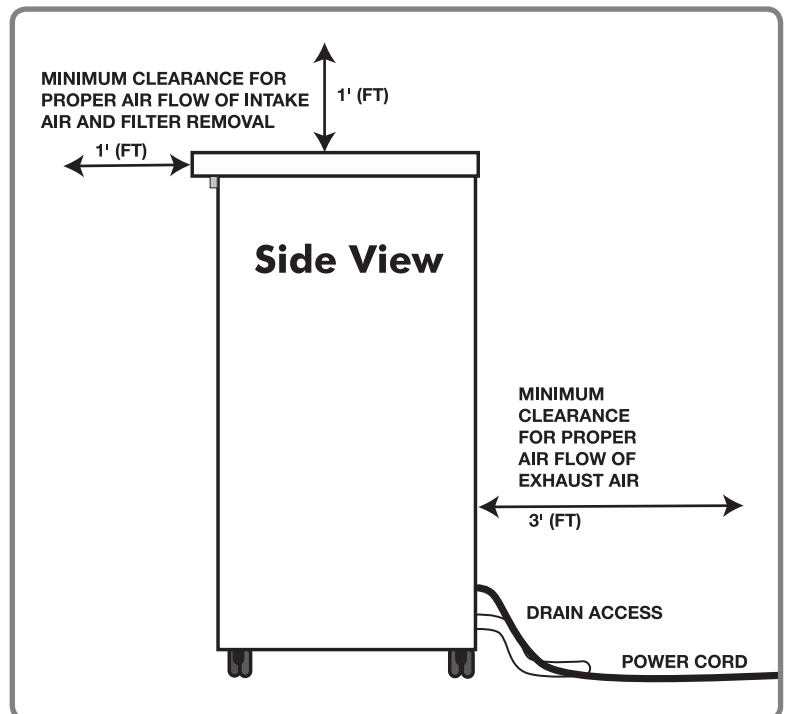

Drain Installation

The Santa Fe Rx generates condensate. A 20' condensate hose comes attached to the unit. Be sure the hose is not kinked or otherwise restricted so water can pass through the hose freely. If a drain is not convenient, a small hole can be drilled through the floor or wall to access a drain or outside. If the Santa Fe Rx is located too far from the floor drain and the provided hose does not reach, the hose can be extended. It should, however, be extended with a hose of larger inner diameter (1/4" I.D. or greater) to avoid overloading the pump. Be sure the extension is at a down-ward slope to the drain. Larger diameter hose is available from the factory or may be purchased from many hardware stores. If the hose can not be routed to a drain or outside, a reservoir container with an overflow switch can be used.

If the hose is routed outside, it must exit the building with a downward slant. This will allow the water in the hose to drain from it when the pump shuts off, preventing it from freezing.

The Santa Fe Rx is equipped with a condensate pump to remove the water that is condensed during dehumidification. This allows the water to be discharged to a distant location, or to be pumped up to 15' above the Santa Fe Rx. Pump failure will cause the unit to stop dehumidifying via a safety switch.

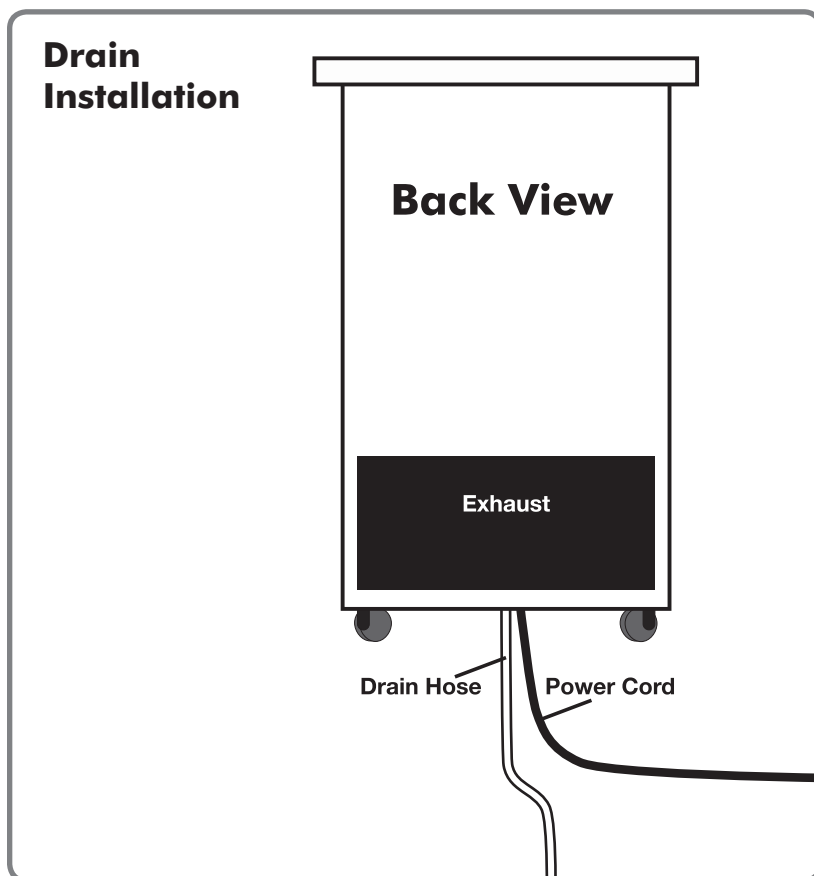

Operation

Humidity Control Adjustment

The humidity control knob is located under the removable top (top must be lifted off to access). Turning the knob clockwise lowers humidity. Turning it counter clockwise increases the humidity set point and eventually shuts the unit off.

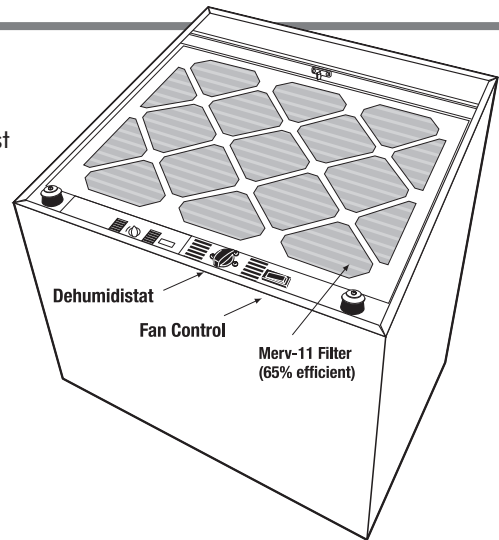
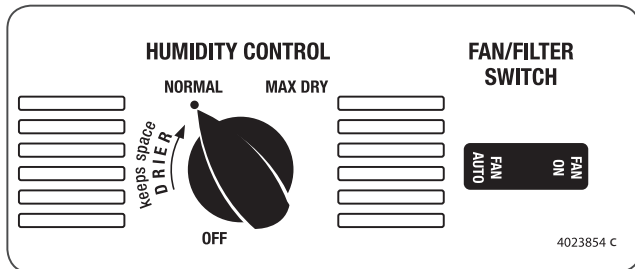

The dehumidifier will run continuously until the relative humidity (RH) is reduced to the humidity control setting. Setting the humidity control to lower RH levels will NOT increase the unit's dehumidification rate, it will simply run longer to reduce the area's RH to the setting.

The Santa Fe Rx (and refrigerant based dehumidifiers in general) will reduce a warm space's RH to a lower level than that of a cool space. For example, the Santa Fe Rx may reduce an 80°F space to 30% RH. However, if the same space is 65°F, it may only reduce it to 45-50% RH.

A humidity meter is supplied upon return of the survey warranty registration card: a meter is recommended to accurately monitor humidity levels. Additional meters are available for purchase from the factory.



The Acurite Hygrometer (part number 4029577) is available to accurately monitor humidity levels. Please contact your dealer or order online.

Fan Operation

Lifting off the top accesses the blower switch. It is located near the humidity control dial.

Turning the fan switch "FAN ON" will cause the unit's internal blower to run continuously, whether the unit is dehumidifying or not. This function is desirable if the unit is used for air circulation or filtration. Turning the fan switch to "FAN AUTO" will cause the unit's internal blower to run only while the unit is dehumidifying.

Defrost Cycle

This product includes a defrost thermostat. This feature prevents internal damage caused by excessive frost forming within the unit. When the unit is experiencing excessive frost the system will stop dehumidifying and the fan will run until normal operating conditions are present.

Air Filtration

The Santa Fe Rx is equipped with a MERV-13 air filter. An optional MERV-11 filter or HEPA filter is available with the use of the filter housing. The MERV-11 and MERV-13 air filter should be checked and replaced every three to six months while the HEPA filter could last up to 3-4 years or more providing the MERV-11 or MERV-13 filter is changed regularly. Operating the unit with a dirty filter will reduce dehumidifier capacity and efficiency. Bulk activated carbon granules are also available for purchase and can be sprinkled over the top of the standard MERV-11 or MERV-13 filter on the inlet of the dehumidifier. To order more filters, visit www.ThermastorFilters.com.

⚠ CAUTION!

MAKE SURE UNIT IS OFF BEFORE CHANGING THE FILTER. FAILURE TO FOLLOW FILTER HANDLING INSTRUCTIONS MAY RESULT IN IMPROPER FUNCTION OF THE DEHUMIDIFIER AND CAUSE PREMATURE FILTER WEAR OR UNIT DAMAGE.

Changing the Standard MERV-11 or MERV-13 Air Filter

For greatest filtration and efficiency of the Santa Fe Rx, it is recommended the the MERV-11 filter be replaced every three to six months.

Step 1 - Undo the three latches. Remove the top of the unit by sliding it forward. Next, lift the front edge up first, then the back. Remove the filter by pulling it up and out.

Step 2 - Insert the new filter by gently placing it back into the top of the unit. Be sure the arrows on the filter are pointing down towards the unit. Reinstall the top cover by sliding the back in first, then the front. Then slide it all the way back until it is securely into place.

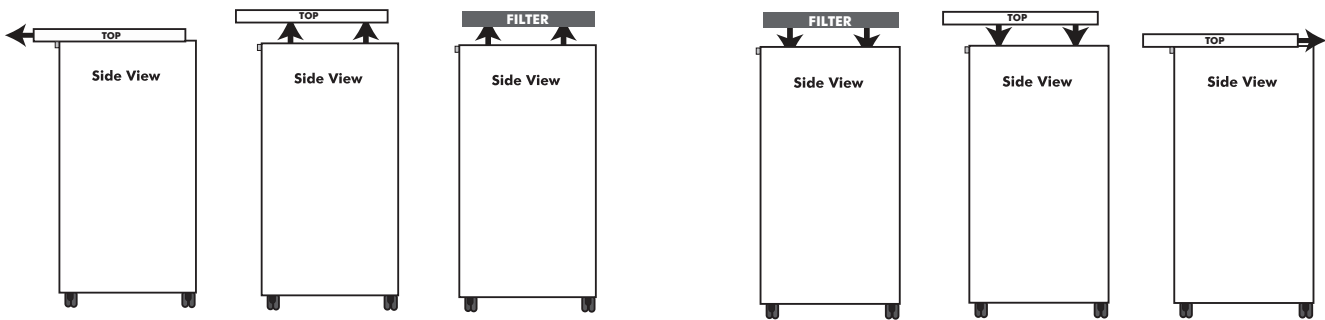

Changing the Optional Filters

An optional filter housing is available that attaches to the back of the machine and adds 6-1/2" to the units' depth. It allows the choice of using a MERV-14 filter (need two) or a HEPA filter. These filters are accessible by removing the 4 screws from the filter frame top cover.

The optional filters have long lives when prefiltered by the standard MERV-11 or MERV-13 filter; they can last many years in certain conditions. How long they last can, however, vary widely depending upon the following: unit run time, air contamination level and standard inlet filter cleanliness. Given the expense of the optional filters, it can be costly to change them prematurely. The following test helps determine when they should be changed.

Air exiting the bottom rear of the unit enters the filter frame, then passes through the optional filter and into the room. If the filter is dirty, air pressure builds up before the filter. To check this pressure, remove the plastic plug from the filter frame top; you will feel air coming out of the hole with the unit running. Place the ping pong ball that came with the filter frame on the hole and let go (any marked, regulation sized ping pong ball will work). If the ball does not move or only bounces slightly and does not spin continuously, the filter is clean enough for continued use. If the ball floats above the hole and starts to spin and perhaps wobble within 30 seconds, the filter needs to be changed.

See the instruction sheet that comes with the optional filter to learn how to change the filters.

Santa Fe Rx with Secondary Filter Housing

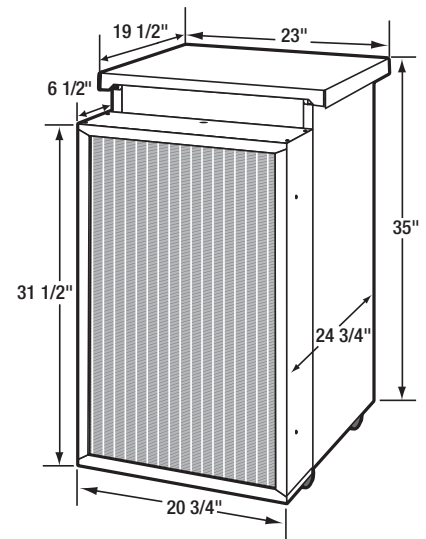

Air Filtration

MERV Rating Chart

Standard 52.5 Minimum Efficiency Reporting Value	Dust Spot Efficiency	Arrestance	Typical Controlled Contaminant	Typical Applications and Limitations	Typical Air Filter/Cleaner Type
20	n/a	n/a	< 0.30 pm particle size	Cleanrooms	≥99.999% eff. On .10-20 pm Particles
19	n/a	n/a	Virus (unattached)	Radioactive Materials	Particulates
18	n/a	n/a	Carbon Dust	Pharmaceutical Man.	Particulates
17	n/a	n/a	All Combustion smoke	Carcinogenetic Materials	≥99.97% eff. On .30 pm Particles
16	n/a	n/a	.30-1.0 pm Particle Size	General Surgery	Bag Filter - Nonsupported
15	>95%	n/a	All Bacteria	Hospital Inpatient Care	microfine fiberglass or synthetic media, 12-36 in. deep, 6-12 pockets.
14	90-95%	>98%	Most Tobacco Smoke	Smoking Lounges	Box Filter - Rigid Style Cartridge Filters 6 to 12" deep may use lofted or paper media.
13	89-90%	>98%	Proplet Nuceli (Sneeze)	Superior Commercial Buildings	lofted or paper media.
12	70-75%	>95%	1.0-3.0 pm Particle Size Legionella	Superior Residential	Bag Filter - Nonsupported microfine fiberglass or synthetic media, 12-36 in. deep, 6-12 pockets.
11	60-65%	>95%	Humidifier Dust Lead Dust	Better Commercial Buildings	Box Filter - Rigid Style Cartridge Filters 6 to 12" deep may use lofted or paper media.
10	50-55%	>95%	Milled Flour Auto Emissions	Hospital Laboratories	
9	40-45%	>90%	Welding Fumes		
8	30-35%	>90%	3.0-10.0 pm Particle Size	Commercial Buildings	Pleated Filters - Disposable, extended surface area, thick with cotton-polyester blend media, cardboard frame.
7	25-30%	>90%	Mold Spores Hair Spray	Better Residential	Cartridge Filters - Graded density viscous coated cube or pocket filters, synthetic media.
6	<20%	85-90%	Fabric Protector Dusting Aids	Industrial Workplace	Throwaway - Disposable synthetic panel filter.
5	<20%	80-85%	Cement Dust Pudding Mix	Paint Booth Inlet	
4	<20%	75-80%	>10.0 pm Particle Size Pollen	Minimal Filtration	Throwaway - Disposable fiberglass or synthetic panel filter.
3	<20%	70-75%	Dust Mites Sanding Dust	Residential	Washable - Aluminum Mesh.
2	<20%	65-70%	Spray Paint Dust		Electrostatic - Self charging woven panel filter.
1	<20%	<65%	Textile Fibers Carpet Fibers	Window A/C Units	

http://www.mechreps.com/PDF/Merv_Rating_Chart.pdf

Electrical Requirements

The Santa Fe Rx plugs into a common grounded 115VAC outlet. The device draws 5.4 Amps at 80°F and 60% RH. Locate the dehumidifier in an area where the cord's length (10') easily reaches a 115 VAC electrical outlet with a minimum of 15 Amp circuit capacity. If used in an area that may become wet, a GFCI protected circuit is recommended. The unit should not be used in areas prone to flooding. Consult local electrical codes for any further information.

An optional remote dehumidistat is available for use with the Santa Fe Rx and is to be located remotely from the dehumidifier.

⚠ CAUTION!

ELECTRICAL SHOCK HAZARD: Electrical power must be present to perform some tests. These tests should be performed by a qualified service person.

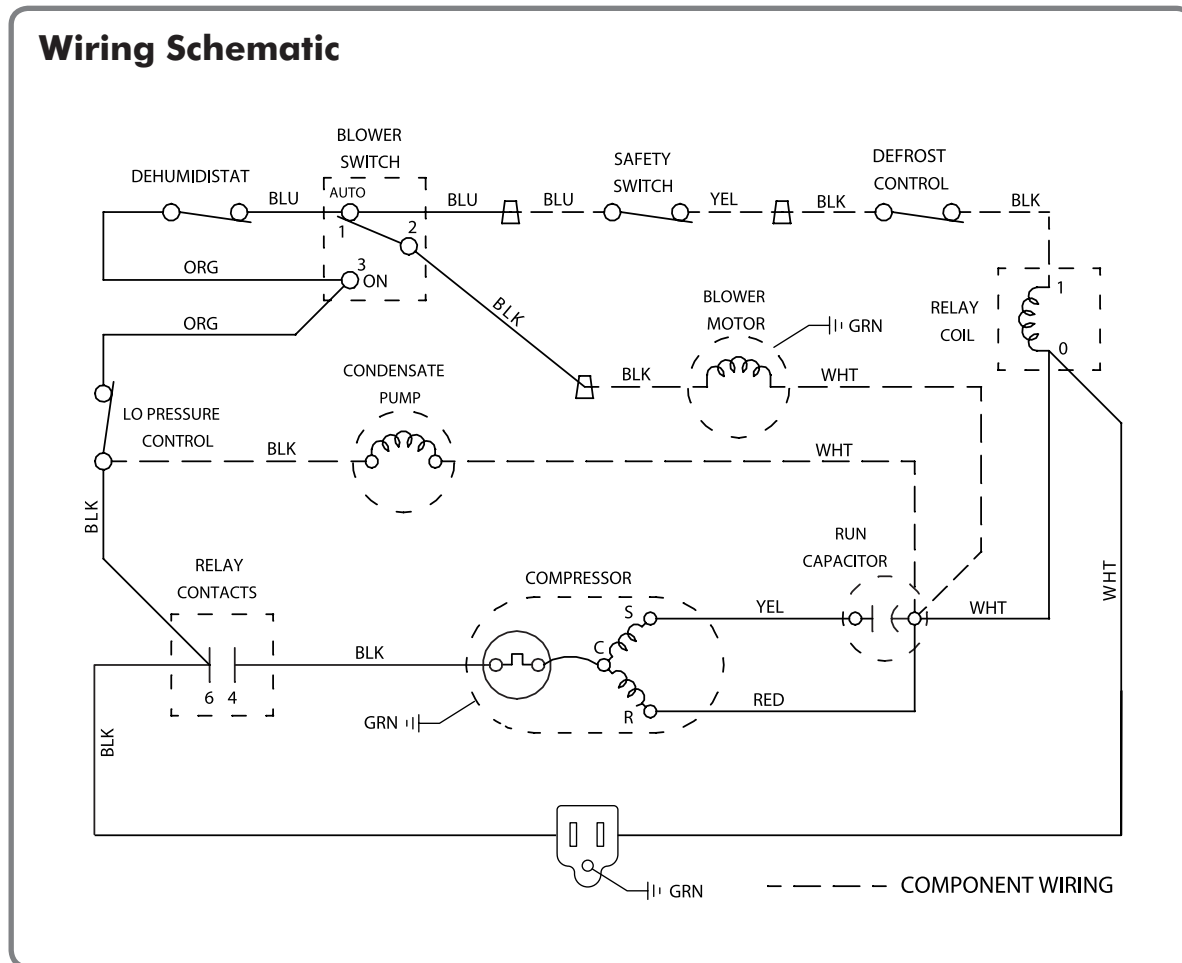

Service

WARNING!

SERVICING THE SANTA FE RX, WITH ITS HIGH PRESSURE REFRIGERANT SYSTEM AND HIGH VOLTAGE CIRCUITRY PRESENTS A HEALTH HAZARD WHICH COULD RESULT IN DEATH, SERIOUS BODILY INJURY, AND/OR PROPERTY DAMAGE. ONLY QUALIFIED SERVICE PEOPLE SHOULD SERVICE THIS UNIT.

Replacement Parts

4022254	Accumulator
4028240	Blower, with Capacitor
4023871	Top Catch & Strike Set
4033032-03	Capacitor, 35 Mfd
4036164-02	Capillary Tube
4023604	Caster, Swivel, 2"
4028226-02	Condenser Coil
4029567	Compressor
4034605-01	Condensate Pump, Low Profile
4023661	Cord/Wire Harness
4025741	Defrost Control Thermostat
4021648	Defrost Control Mounting Clip
4033925-05	Evaporator Coil
4029510	Filter, Drier
4023747	Hose, Vinyl, .19 ID x20'
4027172	Humidity Controller
4021495	Knob, .25 Shaft
4023857	Label, Wiring Diagram
4023860	Metal Top
4029508	Low Pressure Control
1970010	Relay, 25A
4025560	Rocker Switch For Fan

Refrigerant Charging

If the refrigerant charge is lost due to service or a leak, a new charge must be accurately weighed in. If any of the old charge is left in the system, it must be recovered before weighing in the new charge. Refer to the unit nameplate for the correct charge weight and refrigerant type.

Compressor/Capacitor Replacement

This compressor is equipped with a two terminal external overload and a run capacitor, but no start capacitor or relay.

Troubleshooting

CAUTION!

TROUBLESHOOTING SHOULD BE PERFORMED BY A QUALIFIED HVAC TECHNICIAN.

Symptom	Possible Reason
Neither fan nor compressor running. Dehumidification is being called for.	<ol style="list-style-type: none"> 1. Dehumidifier unplugged or no power to outlet. 2. Humidity control set too high. 3. Loose connection in internal or control wiring. 4. Defective compressor relay.
Compressor is not running. Dehumidification is being called for. Fan is running.	<ol style="list-style-type: none"> 1. Defective compressor run capacitor. 2. Loose connection in compressor circuit. 3. Defective compressor overload. 4. Defective compressor. 5. Defrost thermostat open.
Compressor cycles on and off. Dehumidification is being called for.	<ol style="list-style-type: none"> 1. Low ambient temperature and/or humidity causing unit to cycle through defrost mode. 2. Defective compressor overload. 3. Defective compressor. 4. Defrost thermostat defective. 5. Dirty air filter(s) or air flow restricted. 6. Defective fan or relay.

Service - Troubleshooting

CAUTION!

TROUBLESHOOTING SHOULD BE PERFORMED BY A QUALIFIED HVAC TECHNICIAN.

Symptom	Possible Reason	Troubleshooting Procedure
Fan is not running. Dehumidification or fan is being called for.	<ol style="list-style-type: none"> Loose connection in fan circuit. Obstruction prevents fan impeller rotation. Defective fan. Defective fan relay. 	<p> WARNING!</p> <p>ELECTRICAL SHOCK HAZARD: ELECTRICAL POWER MUST BE PRESENT TO PERFORM SOME TESTS. THESE TESTS SHOULD BE PERFORMED BY A QUALIFIED SERVICE PERSON.</p>
Low dehumidification capacity (evaporator is frosted continuously). Dehumidification is being called for.	<ol style="list-style-type: none"> Defrost thermostat loose or defective. Low refrigerant charge. Dirty air filter(s) or air flow restricted. Excessively restrictive ducting connected to unit. 	<p>Troubleshooting Procedure for Performance Related Issues</p> <p>This method of diagnosis is used to function check the internal components in the dehumidifier. This is to be used when a performance issue is suspected.</p> <ol style="list-style-type: none"> Set the humidity controller all the way to the most humid setting or off position – Did the unit shut off? If yes, turn the fan setting to the ON position – does the fan start? If fan starts, leave in the fan ON position and set the humidity all the way to driest setting. May have to wait 5 minutes for the compressor to start. Listen for a distinct buzzing/humming sound of a compressor starting up – do you hear this noise? If compressor is running and continues to run, after about 15 minutes you should feel a slight increase in air temperature being discharged out of the discharge air side of the unit. If so, depending on your environmental conditions (temp/Rh%), you should see some water production out of the hose within 30 minutes or so. (<i>Note: If the room temperature is 55 degrees or below and/or in area of low relative humidity, the dehumidifier will produce little to no water.</i>) Collecting the water removed in a 24 hour period will give a measurement of performance.
Dehumidifier removes some water, but not as much as expected.	<ol style="list-style-type: none"> Air temperature and/or humidity have dropped. Humidity meter and or thermometer used are out of calibration. Unit has entered defrost cycle. Dirty air filter(s) or air flow is restricted. Defective defrost thermostat. Low refrigerant charge. Air leak such as loose cover or ducting leaks. Defective compressor. Restrictive ducting. 	

Warranty

Limited Warranty. Therma-Stor, LLC (“Therma-Stor”) warrants as follows: (i) the Santa Fe Rx dehumidifier (“Product”) will be free of material defects in workmanship or materials for a period of 2 years (“Two-Year Warranty”) following the date of initial purchase of such Product by an original customer purchasing from Therma-Stor or an authorized reseller (“Customer”); and (ii) the Product’s components will be free of material defects in workmanship or materials for a period of **six (6) years** following the date of initial purchase of such Product by a Customer.

Limitation of Remedies. CUSTOMER’S SOLE AND EXCLUSIVE REMEDY UNDER THE ABOVE LIMITED WARRANTY AND THERMA-STOR’S ENTIRE LIABILITY THEREUNDER, SHALL BE, AT THE SOLE OPTION OF THERMA-STOR, REPLACEMENT OR REPAIR OF SUCH PRODUCT OR ITS COMPONENTS (“COMPONENTS”) BY THERMA-STOR OR THERMA-STOR’S AGENTS ONLY. REFRIGERANT, PIPING, SUPPLIES, TRANSPORTATION COSTS, LABOR COSTS INCURRED IN REPAIR OR REPLACEMENT OF SUCH COMPONENTS ARE NOT INCLUDED. THIS DISCLAIMER AND EXCLUSION SHALL APPLY EVEN IF THE EXPRESS WARRANTY AND LIMITED REMEDY SET FORTH HEREIN FAILS OF ITS ESSENTIAL PURPOSE. CUSTOMER ACKNOWLEDGES THAT NO REPRESENTATIVE OF THERMA-STOR OR OF ITS AFFILIATES OR RESELLERS IS AUTHORIZED TO MAKE ANY REPRESENTATION OR WARRANTY ON BEHALF OF THERMA-STOR OR ANY OF ITS AFFILIATES OR RESELLERS THAT IS NOT IN THIS AGREEMENT. Notwithstanding the above, during the term of the Two-Year Warranty only, Therma-Stor will provide, free of charge to Customer, all Components and labor (except costs related to removal and installation of Product) required to fulfill its obligations under such Two-Year Warranty.

Disclaimer of Warranties. EXCEPT FOR ABOVE LIMITED WARRANTY, WHICH IS THE SOLE AND EXCLUSIVE WARRANTY PROVIDED WITH RESPECT TO THE PRODUCT AND ITS COMPONENTS, THERMA-STOR HEREBY DISCLAIMS ALL EXPRESS AND IMPLIED WARRANTIES, INCLUDING, WITHOUT LIMITATION, THE IMPLIED WARRANTIES OF MERCHANTABILITY AND FITNESS FOR A PARTICULAR PURPOSE.

Warranty Limitations. The foregoing limited warranty extends only to a Customer and shall be null and void upon attempted assignment or transfer. A “defect” under the terms of the limited warranty shall not include problems resulting from Customer’s or Customer’s employees’, agents’, invitees’ or a third party’s misuse, improper installation, improper design of any system in which the Product is included, abuse, lack of normal care, failure to follow written instructions, tampering, improper repair, or freezing, corrosion, acts of nature or other causes not arising out of defects in Therma-Stor’s workmanship or material. If a Product or Component is replaced while under warranty, the applicable limited warranty period shall not be extended beyond the original warranty time period. The limited warranty does not cover any costs related to changes to a Product or Component that may be required by any codes, laws, or regulations that may become effective after initial purchase of the Product by Customer.

Customer Responsibilities. As a further condition to obtaining warranty coverage hereunder, the Customer must send a valid warranty claim to Therma-Stor such that Therma-Stor receives such claim prior to the end of the applicable warranty period. Therma-Stor shall have no obligation hereunder with respect to any claim received by Therma-Stor after the expiration of the applicable warranty period. As a further condition to obtaining warranty coverage hereunder, the Customer must present forms of invoices evidencing proof of purchase of a Product. If such invoices do not clearly indicate the date of initial purchase by a Customer, the applicable Product’s date of manufacture will be used instead of the date of initial purchase for the purpose of calculating the commencement of the applicable warranty period. Warranty service must be performed by Therma-Stor or a servicer authorized by Therma-Stor. In order to obtain warranty service, the Customer should call Therma-Stor at 1-800-533-7533 and ask for the Therma-Stor Products Service Department, which will then arrange for applicable warranty service. Warranty service will be performed during customary, daytime working hours. If the Product must be shipped for service, Customer shall be solely responsible for properly packaging the Product, for all freight charges, and for all risk of loss associated with shipment.

Limitation of Liability. IN NO EVENT SHALL THERMA-STOR, IN CONNECTION WITH THE DESIGN, SALE, INSTALLATION, USE, REPAIR, REPLACEMENT OR PERFORMANCE OF ANY PRODUCT, COMPONENT, PART THEREOF OR WRITTEN MATERIAL PROVIDED THEREWITH, BE LIABLE, TO THE EXTENT ALLOWED UNDER APPLICABLE LAW, UNDER ANY LEGAL THEORY FOR ANY SPECIAL, DIRECT, INDIRECT, COLLATERAL OR CONSEQUENTIAL DAMAGES OF ANY KIND. NOTWITHSTANDING THE ABOVE LIMITATIONS AND WARRANTIES, THE SOLE AND EXCLUSIVE LIABILITY OF THERMA-STOR, REGARDLESS OF THE NATURE OR THEORY OF THE CLAIM, SHALL UNDER NO CIRCUMSTANCES EXCEED THE PURCHASE PRICE OF THE PRODUCT, COMPONENT OR PART UPON WHICH THE CLAIM IS PREMISED.

Applicable Law and Venue. ANY ARBITRATION, ENFORCEMENT OF AN ARBITRATION OR LITIGATION RELATED TO THE PRODUCT WILL BE BROUGHT EXCLUSIVELY IN DANE COUNTY, WISCONSIN, AND CUSTOMER CONSENTS TO THE JURISDICTION OF THE FEDERAL AND STATE COURTS LOCATED THEREIN, SUBMITS TO THE JURISDICTION THEREOF AND WAIVES THE RIGHT TO CHANGE VENUE. CUSTOMER FURTHER CONSENTS TO THE EXERCISE OF PERSONAL JURISDICTION BY ANY SUCH COURT WITH RESPECT TO ANY SUCH PROCEEDING.

Miscellaneous. If any term or condition of this Limited Warranty is found by a court of competent jurisdiction to be invalid, illegal or otherwise unenforceable, the same shall not affect the other terms or conditions hereof or thereof or the whole of this Limited Warranty. Any delay or failure by Therma-Stor to exercise any right or remedy will not constitute a waiver of Therma-Stor to thereafter enforce such rights.



www.Santa-Fe-Products.com
1.800.533.7533